

16-Port/24-Port

Ethernet Hub

User's Guide

## **FCC Warning**

This equipment has been tested and found to comply with the regulations for a Class B digital device, pursuant to Part 15 of the FCC Rules. These limits are designed to provide reasonable protection against harmful interference when the equipment is operated in a commercial environment. This equipment generates, uses, and can radiate radio frequency energy and, if not installed and used in accordance with this user's guide, may cause harmful interference to radio communications. Operation of this equipment in a residential area is likely to cause harmful interference, in which case the user will be required to correct the interference at his own expense.

## **CE Mark Warning**

This is a Class B product. In a domestic environment, this product may cause radio interference, in which case the user may be required to take adequate measures.

## **VCCI Mark Warning**

注意

この装置は、情報処理装置等電波障害自主規制協議会(VCCI)の基準に基づく第一種情報技術装置です。この装置を家庭環境で使用すると電波妨害を引き起こすことがあります。この場合には使用者が適切な対策を講ずるよう要求されることがあります。

---

# About this Guide

---

This guide provides instructions for installing all of the products described below. These Ethernet Hubs are all Plug and Play compliant for easy installation.

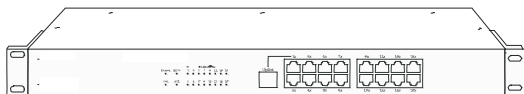

**16-Port Ethernet Hub**

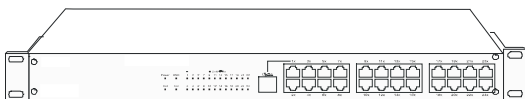

**24-Port Ethernet Hub**

When designing your cable configuration, it is necessary to strictly observe the Ethernet cabling rules. This manual assumes familiarity with the fundamental Ethernet cabling rules and limits; it only describes the details of cable connection.

---

# Rack Mounting

---

The Ethernet Hub may stand alone, or may be mounted in a standard 19-inch equipment rack. Rack mounting produces an orderly installation when you have a number of related network devices. Use the six supplied screws to fasten the supplied mounting brackets to either end of the hub, and fasten the hub into the rack.

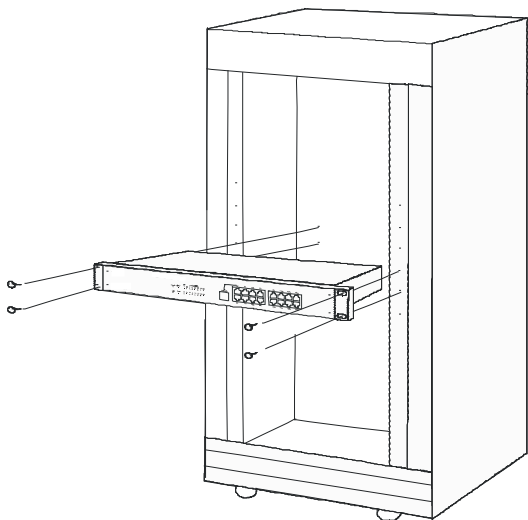

---

# Installing Network Cables

---

Your Ethernet Hub is denominated as a 16-port or 24-port Ethernet Hub according to the number of its front-panel 10BaseT ports. Additionally it has two ports whose connectors are on the rear panel: one 10Base2 port (BNC connector), and one 10Base5 port (AUI connector). These two un-numbered rear-panel ports are logically equivalent with the numbered ports on the front panel of the Ethernet Hub.

By using a rear-panel connector of the Ethernet Hub to connect into an existing coaxial network cable, you can add on a star-topology subnet, connected through the Ethernet Hub

numbered front-panel ports. Alternatively, you can connect into an existing star-topology through a front panel port of the Ethernet Hub, and then add on a bus-topology subnet by connecting the subnet bus to a rear-panel connector of the Ethernet Hub (irrespective of any star-topology subnet that may also be supported by the Ethernet Hub's front-panel ports). In either case, the unused rear-panel connector always remains available to connect a second coaxial cable (alternative type of coaxial cable).

When the Ethernet Hub has no coaxial trunk connection, then both of the rear panel connectors remain available for coaxial

---

station-cable connections. It is useful to keep this in mind when you have some station equipment whose adapters have no 10BaseT port (RJ-45 connector), and thus can only be connected to the hub through a coaxial cable.

## **Station Connections with Twisted-Pair Cable**

Connect each station to the Ethernet Hub by means of a twisted-pair straight cable (10BaseT cable, Category 3, 4, or 5). Plug one RJ-45 connector into a front-panel port of the Ethernet Hub, and plug the other RJ-45 connector into the station's Ethernet adapter.

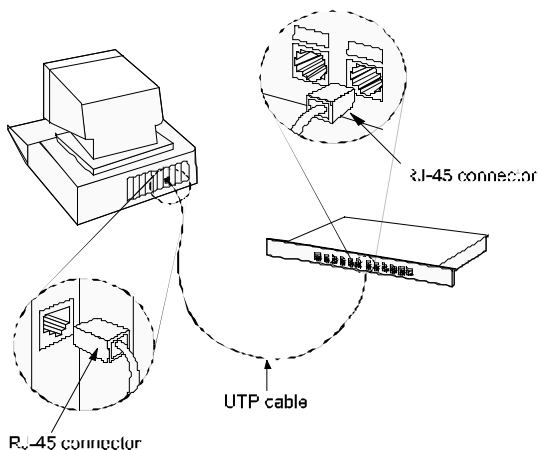

## ***Hub-to-Hub Connections with Twisted-Pair Cable***

In making a hub-to-hub connection involving a Model 16-Port or 24-Port Ethernet Hub, there is the alternative of using a straight cable.

### **Internal Crossover Features**

The Ethernet Hubs, Model 16-Port and 24-Port, feature internal cross-over for Uplink

The port labeled "Uplink" is wired to the same conductors as the Port 1 but with certain pin positions interchanged to provide a cross-over, and thus allow use of a straight cable to make a hub-to-hub connection.

Below in this manual, the term "Uplink" selected will mean that the subject connection is made through the Uplink connector

### **Rules for Using the Uplink Feature**

Uplink should never be selected for a station cable connection. And Uplink should never be selected for a hub-to-hub connection through a crossover cable (because the crossover in the connector wiring would cancel out the crossover in the cable).

Uplink should be selected only for making a hub-to-hub connection with a straight cable. When Uplink is selected at one end of a straight cable, Uplink must not be selected at other end of that cable. (If Uplink were selected at both ends of a straight cable, then the built-in crossovers of the two connectors would cancel

one another, and the hub-to-hub connection would fail.)

Thus the rule for making a hub-to-hub connection with twisted-pair cable is as follows:

To make a hub-to-hub connection with a **straight cable**, Uplink *must* be selected at one end of the cable, and Uplink *must not* be selected at the other end of the cable.

To make a hub-to-hub connection with a **cross-over cable**, Uplink *must not* be selected at either end of the cable.

## **Thin Coaxial Cable Connections**

To connect the Ethernet Hub to a thin coaxial cable (10Base2 cable, also known by its wire-standard name, RG58A/U, and a variety of other informal names), first twist a BNC T-connector onto the rear-panel BNC connector of the Ethernet Hub. Then twist the shell of the cable's connector onto either leg of the BNC T.

If the thin coaxial cable continues on to other nodes, then twist the shell of the continuation cable onto the remaining leg of the BNC T. If there is no continuation (the Ethernet Hub is at the end of the coaxial cable), then it is necessary to twist a 50-ohm terminator onto the remaining open leg of the BNC T.



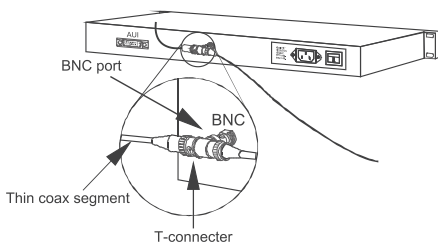

Sometimes several Ethernet Hubs must be co-located to support a larger array of stations than can be handled by a single Ethernet Hub. Then it is useful to stack the Ethernet Hubs by joining their BNC connectors with 0.5 meters patches of thin coaxial cable. Such stacking is just a special case of thin coaxial cable connection as treated above, and the terminator rule is the same: If the stack is at the end of the incoming cable, then a 50-ohm terminator must be substituted for the continuation cable shown in the stacking diagram below.

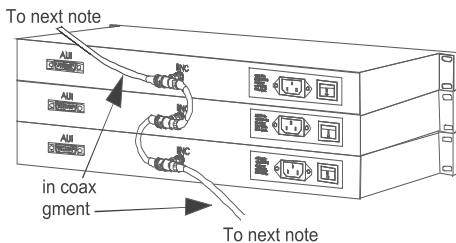

## Thick Coaxial Cable Connections

To connect the Ethernet Hub to a thick coaxial cable (10Base5 cable), it is necessary to have a 10Base5 Ethernet transceiver (tap) on the cable at the Ethernet Hub position. Then run an AUI cable between the transceiver AUI connector and the AUI connector on the rear panel of the Ethernet Hub.

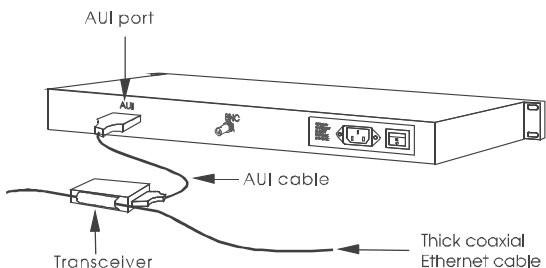

---

## Connecting Power

---

For compatibility with electric service in most areas of the world, the Ethernet Hub power supply automatically adjusts to line power in the range 100 - 250 VAC and 50 - 60 Hz.

Per ordering option, either a Type 1 (US) or Type 2 (European) power cord is supplied with

---

your Ethernet Hub. See Specifications, below, for power cord details.

Ascertain that the power switch on the rear panel of the Ethernet Hub is in the *off* position. Plug the female end of the power cord firmly into the receptacle on the rear panel of the Ethernet Hub. Plug the other end of the power cord into an electric service outlet. Turn on power to the Ethernet Hub by switching its rear-panel power switch to the *on* position.

---

## LED Indicators

---

LED indicators are located on the front panel of the Ethernet Hub.

### **Collision LED**

One Collision LED for all ports. A collision occurs when two stations within a collision domain attempt to transmit at the same time. Intermittent flashing yellow of the Collision LED is normal; the contending adapters resolve each collision by means of a wait-then-retransmit algorithm. Frequency of collisions is an indicator of heavy traffic on the network.

## Power LED

- ◇ **ON:** “power good”.
- ◇ **OFF:** “power bad.” Check to see if the AC power adapter is properly connected, or if the correct AC power adapter is being used.

## BNC LED

- ◇ **Blinking:** Packet reception is occurring.
- ◇ **OFF:** No packet reception.

## AUI LED

- ◇ **Blinking:** Packet reception is occurring.
- ◇ **OFF:** No packet reception.

## Link/Rx LEDs

One Link/Rx LED for each numbered port. Steady green (*Link* state) indicates that the port has good linkage to its partner device. Flashing green (*Receive* state) indicates that the port is receiving data from its partner device.

If the port is connected but the Link/Rx LED is dark, check whether (1) the Ethernet Hub and the partner device both have power, (2) the port cable is firmly seated in its connectors in the Ethernet Hub and in the partner device, (3) the connecting cable is good and is of the correct type, and (4) the partner device, including any network adapter, is functioning.

# Specifications

Data transfer rate:	10 Mbps	
Protocol:	CSMA/CD	
Topologies:	Star, Bus	
EMI Certification:	FCC Class B, VCCI-B, CE B	
AC power:	100 - 240 V, 50 - 60 Hz	
Power consumption:	16-Port:	12 W
	24-Port:	19 W
Dimensions:	W x H x L, mm (including mounting brackets): 440 x 44 x 122	
Weight:	1.85 kg	
Operating temperature:	0° - 55° C	
Humidity:	10 - 90 % non-condensing	
Power cord:	Type 1 (US) or Type 2 (Europe) per purchase order	
	Type 1	Type 2
Plug Rating	125V, 7A	240V, 10A
Cord Rating	125V, 7A	240V, 10A
Length	1830mm (6ft)	1830mm (6ft)
Safety		

Standard	UL, CSA	VDE
----------	---------	-----

6012-1624001

Rev.A1-01

