

MOD-MGL10A-D

1.25Gbps SFP Bi-Directional Transceiver,
10km Reach
1310nm TX / 1550 nm RX

**Features**

- ◆ Dual data-rate of 1.25Gbps/1.063Gbps operation
- ◆ 1310nm FP laser and PIN photodetector for 10km transmission
- ◆ Compliant with SFP MSA and SFF-8472 with simplex LC receptacle
- ◆ Digital Diagnostic Monitoring:
Internal Calibration or External Calibration
- ◆ Compatible with SONET OC-24-LR-1
- ◆ Compatible with RoHS
- ◆ +3.3V single power supply
- ◆ Operating case temperature range of 0°C to +70°C (Commercial)

Applications

- ◆ Gigabit Ethernet
- ◆ Fiber Channel
- ◆ Switch to Switch interface
- ◆ Switched backplane applications
- ◆ Router/Server interface
- ◆ Other optical transmission systems

Description

The SFP-BIDI transceivers are high performance, cost effective modules supporting dual data-rate of 1.25Gbps/1.0625Gbps and 20km transmission distance with SMF.

The transceiver consists of three sections: a FP laser transmitter, a PIN photodiode integrated with a trans-impedance preamplifier (TIA) and MCU control unit. All modules satisfy class I laser safety requirements.

The transceivers are compatible with SFP Multi-Source Agreement (MSA) and SFF-8472. For further information, please refer to SFP MSA.

Module Block Diagram

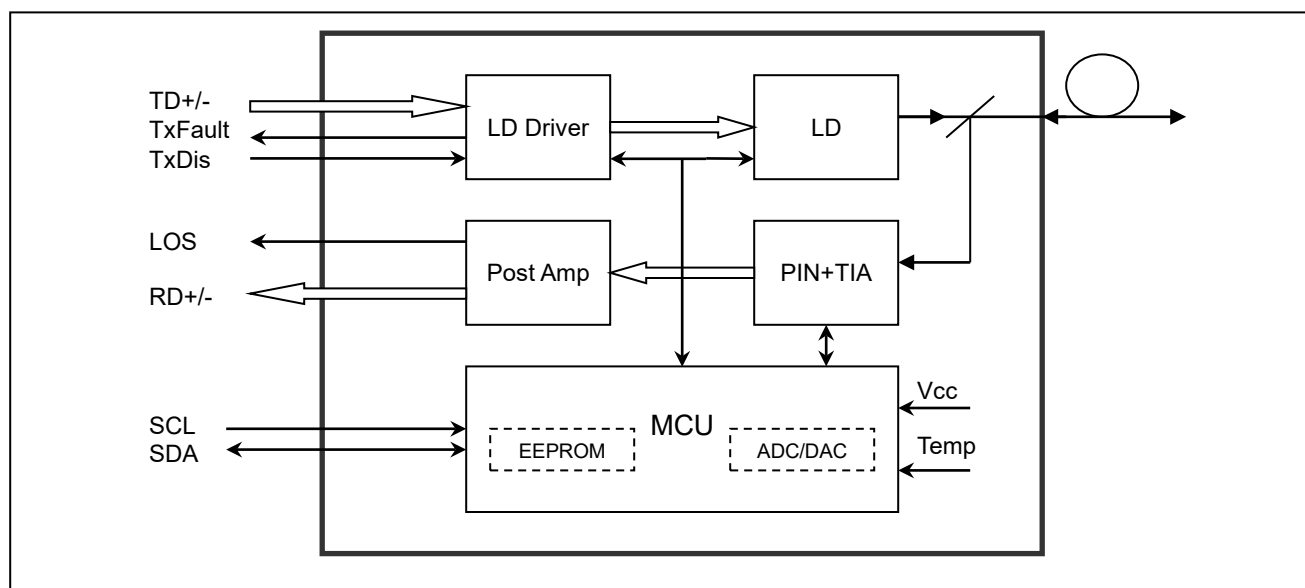

Absolute Maximum Ratings

Parameter	Symbol	Min	Max	Unit
Supply Voltage	Vcc	-0.5	4.5	V
Storage Temperature	Ts	-40	+85	°C
Operating Humidity	-	5	85	%



Recommended Operating Conditions

Parameter		Symbol	Min	Typical	Max	Unit
Operating Case Temperature	Commercial	T _c	0		+70	°C
	Industrial		-40		+85	°C
Power Supply Voltage		V _{cc}	3.13	3.3	3.47	V
Power Supply Current		I _{cc}		200	300	mA
Data Rate	Gigabit Ethernet			1.25		Gbps
	Fiber Channel			1.063		

Optical and Electrical Characteristics

Parameter		Symbol	Min	Typical	Max	Unit	Notes
Transmitter							
Centre Wavelength		λ _c	1260	1310	1360	nm	
Spectral Width (RMS)		σ			4	nm	
Average Output Power		P _{out}	-9		-3	dBm	1
Extinction Ratio		ER	9			dB	
Optical Rise/Fall Time (20%~80%)		t _r /t _f			0.26	ns	
Data Input Swing Differential		V _{IN}	400		1800	mV	2
Input Differential Impedance		Z _{IN}	90	100	110	Ω	
TX Disable	Disable		2.0		V _{cc}	V	
	Enable		0		0.8	V	
TX Fault	Fault		2.0		V _{cc}	V	
	Normal		0		0.8	V	
Receiver							
Centre Wavelength		λ _c	1480		1580	nm	
Receiver Sensitivity					-23	dBm	3
Receiver Overload			-3			dBm	3
LOS De-Assert		LOS _D			-24	dBm	



LOS Assert	LOS _A	-35			dBm	
LOS Hysteresis		1		4	dB	
Data Output Swing Differential	V _{out}	400		1800	mV	4
LOS	High	2.0		V _{cc}	V	
	Low			0.8	V	

Notes:

1. The optical power is launched into SMF.
2. PECL input, internally AC-coupled and terminated.
3. Measured with a PRBS 2⁷-1 test pattern @1250Mbps, BER ≤1×10⁻¹².
4. Internally AC-coupled.

Timing and Electrical

Parameter	Symbol	Min	Typical	Max	Unit
Tx Disable Negate Time	t _{on}			1	ms
Tx Disable Assert Time	t _{off}			10	μs
Time To Initialize, including Reset of Tx Fault	t _{init}			300	ms
Tx Fault Assert Time	t _{fault}			100	μs
Tx Disable To Reset	t _{reset}	10			μs
LOS Assert Time	t _{loss_on}			100	μs
LOS De-assert Time	t _{loss_off}			100	μs
Serial ID Clock Rate	f _{serial_clock}			400	KHz
MOD_DEF (0:2)-High	V _H	2		V _{cc}	V
MOD_DEF (0:2)-Low	V _L			0.8	V

The Advanced Networking Technologywww.repotec.com**Diagnostics Specification**

Parameter	Range	Unit	Accuracy	Calibration
Temperature	0 to +70	°C	±3°C	Internal / External
Voltage	3.0 to 3.6	V	±3%	Internal / External
Bias Current	0 to 100	mA	±10%	Internal / External
TX Power	-9 to -3	dBm	±3dB	Internal / External
RX Power	-23 to -3	dBm	±3dB	Internal / External



Digital Diagnostic Memory Map

The transceivers provide serial ID memory contents and diagnostic information about the present operating conditions by the 2-wire serial interface (SCL, SDA).

The diagnostic information with internal calibration or external calibration all are implemented, including received power monitoring, transmitted power monitoring, bias current monitoring, supply voltage monitoring and temperature monitoring.

The digital diagnostic memory map specific data field defines as following.

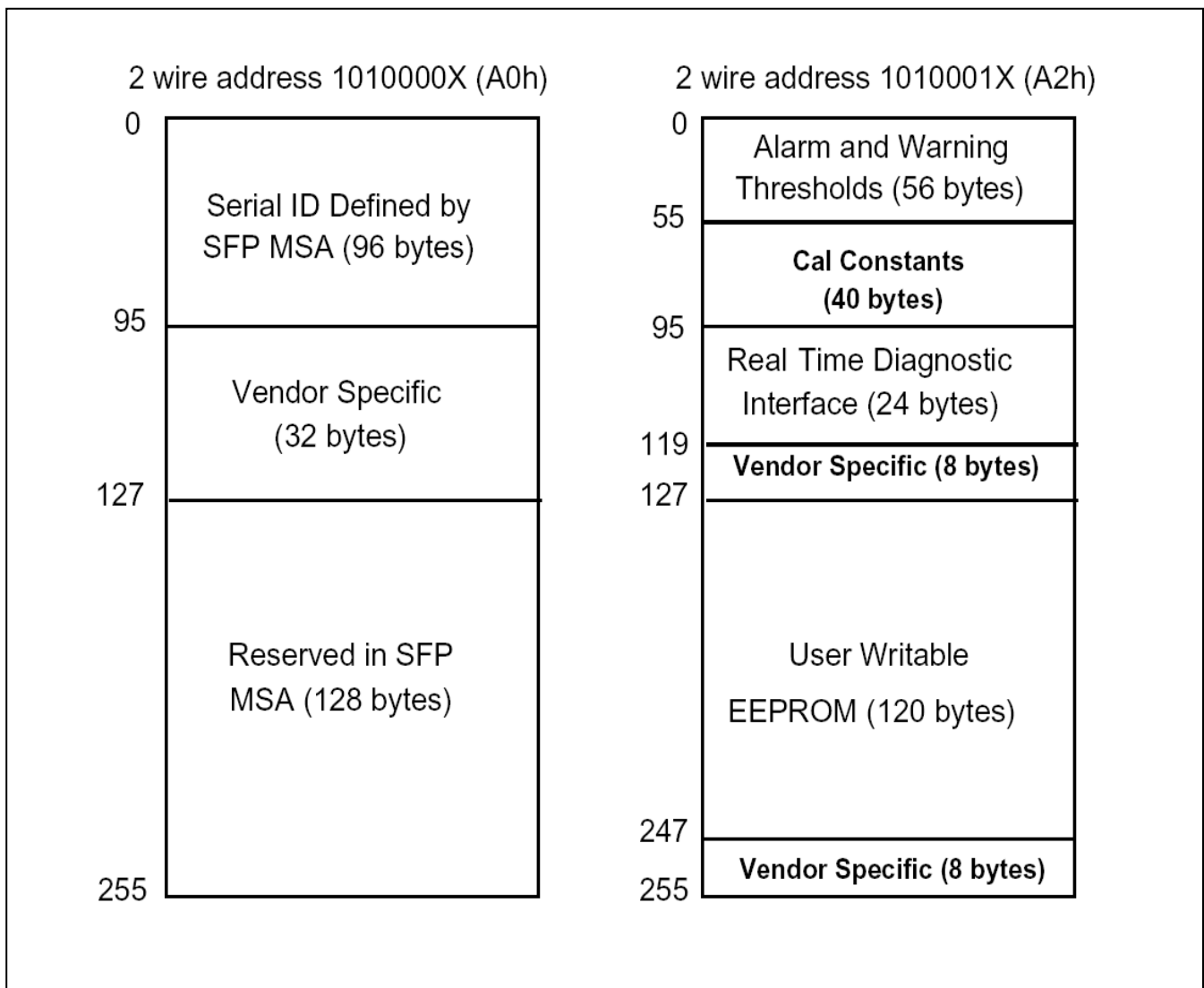



Pin Definitions

Pin Diagram

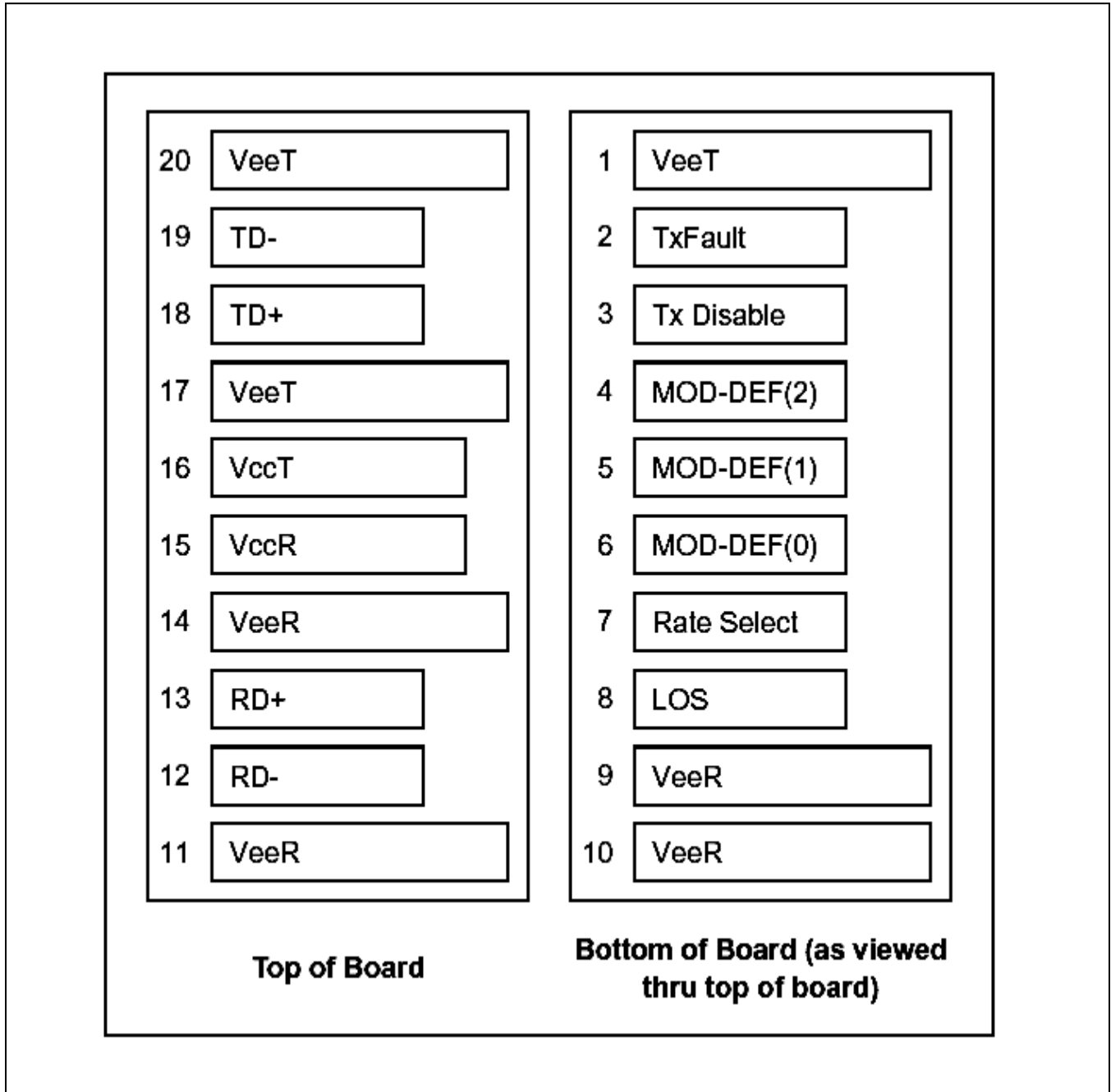



Pin Descriptions

Pin	Signal Name	Description	Plug Seq.	Notes
1	VEET	Transmitter Ground	1	
2	TX FAULT	Transmitter Fault Indication	3	Note 1
3	TX DISABLE	Transmitter Disable	3	Note 2
4	MOD_DEF(2)	SDA Serial Data Signal	3	Note 3
5	MOD_DEF(1)	SCL Serial Clock Signal	3	Note 3
6	MOD_DEF(0)	TTL Low	3	Note 3
7	Rate Select	Not Connected	3	
8	LOS	Loss of Signal	3	Note 4
9	VEER	Receiver ground	1	
10	VEER	Receiver ground	1	
11	VEER	Receiver ground	1	
12	RD-	Inv. Received Data Out	3	Note 5
13	RD+	Received Data Out	3	Note 5
14	VEER	Receiver ground	1	
15	VCCR	Receiver Power Supply	2	
16	VcCT	Transmitter Power Supply	2	
17	VEET	Transmitter Ground	1	
18	TD+	Transmit Data In	3	Note 6
19	TD-	Inv. Transmit Data In	3	Note 6
20	VEET	Transmitter Ground	1	

Notes:

Plug Seq.: Pin engagement sequence during hot plugging.

- 1) TX Fault is an open collector output, which should be pulled up with a 4.7k~10kΩ resistor on the host board to a voltage between 2.0V and Vcc+0.3V. Logic 0 indicates normal operation; Logic 1 indicates a laser fault of some kind. In the low state, the output will be pulled to less than 0.8V.
- 2) TX Disable is an input that is used to shut down the transmitter optical output. It is pulled up within the module with a 4.7k~10kΩ resistor. Its states are:
 - Low (0 to 0.8V): Transmitter on
 - (>0.8V, < 2.0V): Undefined
 - High (2.0 to 3.465V): Transmitter Disabled
 - Open: Transmitter Disabled
- 3) Mod-Def 0,1,2. These are the module definition pins. They should be pulled up with a 4.7k~10kΩ resistor on the host board. The pull-up voltage shall be VccT or VccR.
 - Mod-Def 0 is grounded by the module to indicate that the module is present
 - Mod-Def 1 is the clock line of two wire serial interface for serial ID
 - Mod-Def 2 is the data line of two wire serial interface for serial ID
- 4) LOS is an open collector output, which should be pulled up with a 4.7k~10kΩ resistor. Pull up voltage between 2.0V and Vcc+0.3V. Logic 1 indicates loss of signal; Logic 0 indicates normal operation. In the low state, the output will be pulled to less than 0.8V.
- 5) RD-/+: These are the differential receiver outputs. They are internally AC-coupled 100 differential lines which should be terminated with 100Ω (differential) at the user SERDES.
- 6) TD-/+: These are the differential transmitter inputs. They are internally AC-coupled, differential lines with 100Ω differential termination inside the module.

Recommended Interface Circuit

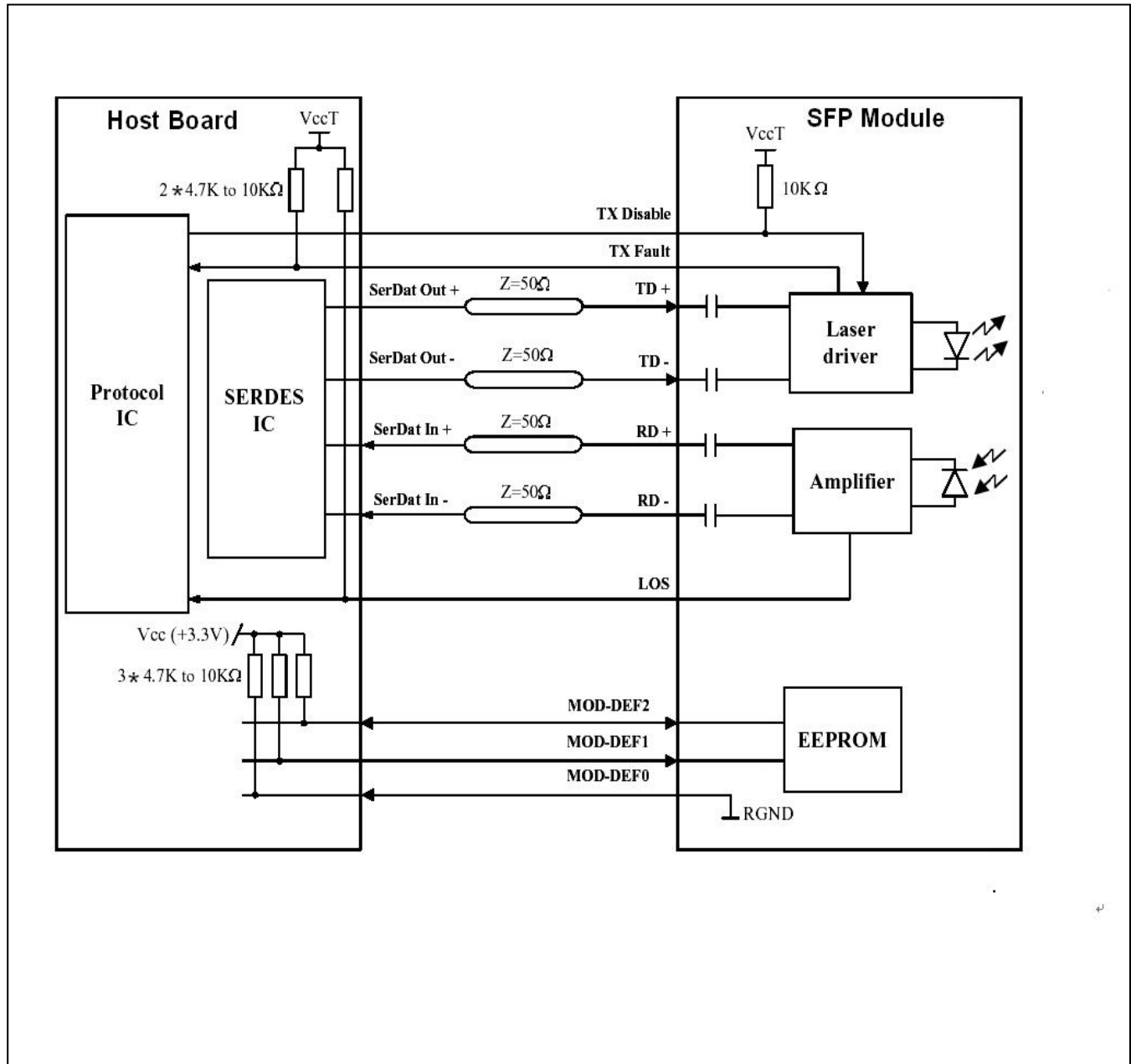

Mechanical Dimensions

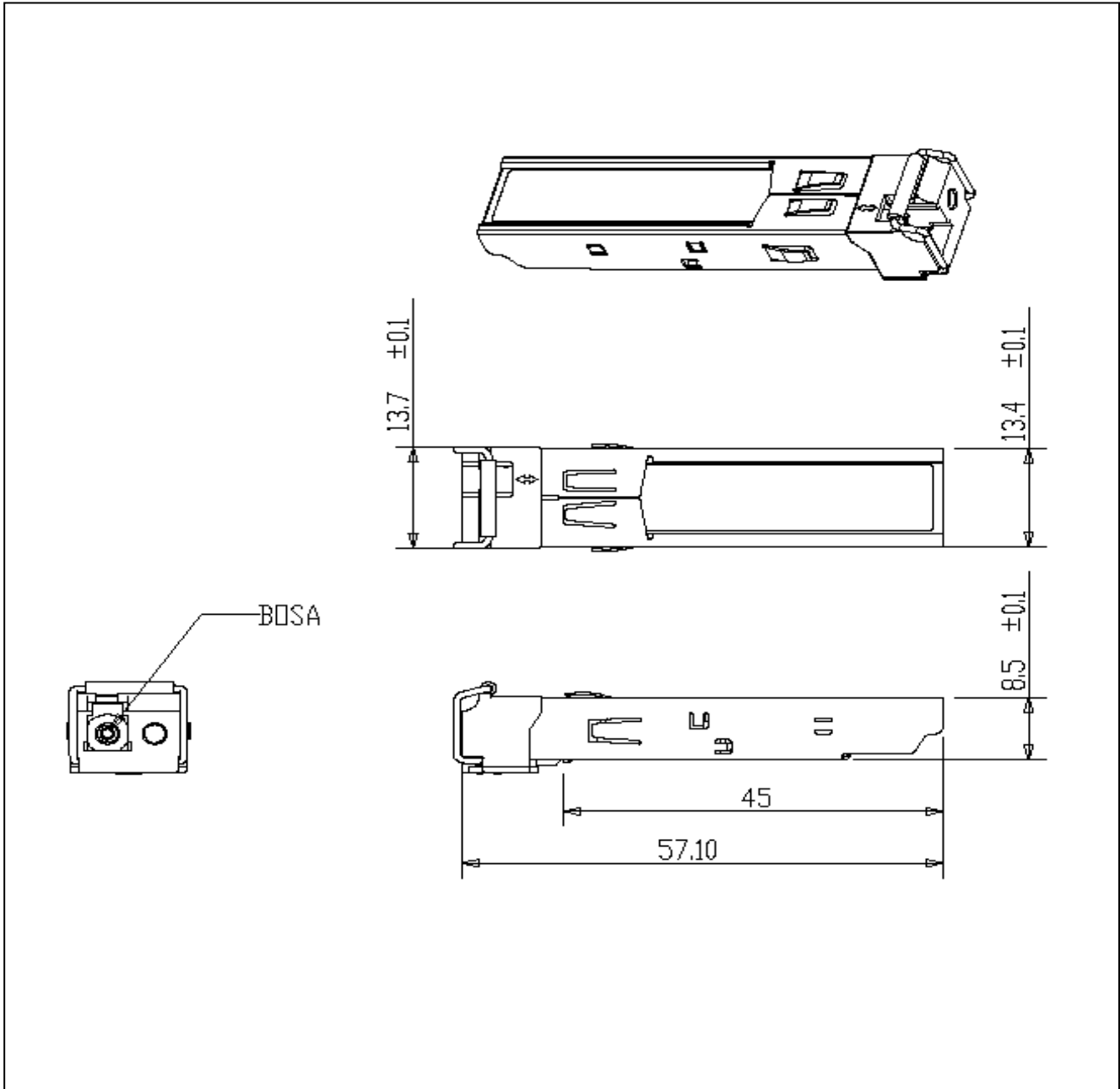

Regulatory Compliance

REPOTEC SFP-BIDI transceiver is designed to be Class I Laser safety compliant and is certified per the following standards:

Feature	Agency	Standard	Certificate / Comments
Laser Safety	FDA	CDRH 21 CFR 1040 and Laser Notice No. 50	1120289-000
Product Safety	BST	EN 60825-1: 2007 EN 60825-2: 2004 EN 60950-1: 2006	BT0905142009
Environmental protection	SGS	RoHS Directive 2002/95/EC	GZ0902008347/CHEM
EMC	WALTEK	EN 55022:2006+A1:2007 EN 55024:1998+A1+A2:2003 -	WT10093768-D-E-E

Ordering information

Part Number	Product Description
MOD-MGL10A-D	1310nm, 1.25Gbps, LC,10km, 0°C~+70°C, With Digital Diagnostic Monitoring

References

1. Small Form Factor Pluggable (SFP) Transceiver Multi-Source Agreement (MSA),September 2000.
2. Telcordia GR-253and ITU-T G.957 Specifications.

Important Notice

Performance figures, data and any illustrative material provided in this data sheet are typical and must be specifically confirmed in writing by REPOTEC before they become applicable to any particular order or contract. In accordance with the REPOTEC policy of continuous improvement specifications may change without notice.

The publication of information in this data sheet does not imply freedom from patent or other protective rights of REPOTEC or others. Further details are available from any REPOTEC sales representative.