



RP-IPG321

3-P Gigabit + 1-SFP(100/1G) slot Industrial Ethernet Switch w/ 2-P 802.3at PoE

RP-IPG321 Industrial Ethernet Switch with PoE feature complies with IEEE802.3af and IEEE802.3at. It delivers 60watts power from PoE port to PD devices, and 1 SFP slots is supported.

RP-IPG321 provides power input voltage 48~56Vdc, especially for IP surveillance, traffic monitoring and for a broad range of applications. It can be used as a stand-alone device for buses, trucks, and other vehicles for Surveillance purposes. It can also be cascaded/daisy-chained to other devices to cover wider area through the SFP connection.

With IP-30 standard industrial case protection allows for either DIN rail or wall mounting for efficient use of cabinet space. Its wide operating temperature ranges from -40°C to 75°C for harsh environment.

Features

- Supports 2 PSE ports based on IEEE 802.3at up to 30 Watts per port
- SFP port supports 100Base-FX and 1000Base-X speed
- Support 48~56VDC power inputs for power redundancy
- Support overload current protection
- Support reserve polarity protection
- Supports auto-negotiation and auto-MDI/MDI-X
- Supports store and forward transmission
- Supports flow control
- Rigid IP-30 housing design
- DIN-Rail and wall mounting enabled
- Built-in power DIN for 110/240VAC environment
- Support Wide Operating Temperature -40°C~75°C

Specifications

Standards	<ul style="list-style-type: none"> • IEEE 802.3 10Base-T Ethernet • IEEE 802.3u 100Base-TX Fast Ethernet • IEEE 802.3ab 1000Base-T Gigabit Ethernet • IEEE 802.3z 1000Base-X Gigabit Ethernet • IEEE802.3x Flow Control and Back Pressure, • IEEE802.3af PoE • IEEE802.3at PoE+
Interface	<ul style="list-style-type: none"> • 3 x RJ-45 10/100/1000BaseT(X) auto negotiation, 2 Giga 30Watts PoE 802.3af/at PSE port, Auto MDI/MDI-X, Full/Half duplex and 1 x 10/100/1000M TX • 1 x 100/1000M SFP slot
Switch Architecture	<ul style="list-style-type: none"> • Back-plane (Switching Fabric): 8 Gbps
Data Processing	<ul style="list-style-type: none"> • Store and Forward
Flow Control	<ul style="list-style-type: none"> • IEEE 802.3x Flow Control and Back Pressure
Jumbo Frame	<ul style="list-style-type: none"> • 10KB
MAC Table Size	<ul style="list-style-type: none"> • 8K
Packet Buffer Size	<ul style="list-style-type: none"> • 1Mbits
Network Cable	<ul style="list-style-type: none"> • UTP/STP above Cat.5e Cable, EIA/TIA-568 100-ohm (100m) • Fiber Cable (Multi-mode):50/125um,62.5/125um • Fiber Cable (Single-mode): 9/125um
Protocol	<ul style="list-style-type: none"> • CSMA/CD
LED indicator	<ul style="list-style-type: none"> • PW1(Green), PW2(Green), PW3(Amber), RLY(Amber) • TX/RJ-45 port: LNK (Green), PoE(Amber) • SFP (Green)
DIP Switch	<ul style="list-style-type: none"> • DIP 1: OFF: Port 4 SFP 1000M (Default) ; ON: Port 4 SFP 100M • DIP 2: Reserve
Reserve polarity protection	<ul style="list-style-type: none"> • Present
Overload current protection	<ul style="list-style-type: none"> • Present
Power Supply	<ul style="list-style-type: none"> • Redundant Dual DC 48V-56V Power Input • PoE input 48-56VDC
Power Consumption	<ul style="list-style-type: none"> • 4W@48 VDC full load, Without PoE
Alarm Relay Contact	<ul style="list-style-type: none"> • Relay outputs with current carrying capacity of 1 A @24VDC, • Relay in open circuit mode when 2 powers are connected. in short circuit mode when only one power supply is connected
PoE power budget	<ul style="list-style-type: none"> • PoE power per port 30watts • Maximum total power 65Watts, Supports IEEE802.3af/at
Removable Terminal Block	<ul style="list-style-type: none"> • Provide 2 Redundant power, Alarm relay contact, 6 Pin. And circular Power Din for power adapter • Wire range: 0.34mm² to 2.5mm² • Solid wire (AWG):12-24/14-22 • Stranded wire(AWG): 12-24/14-22 • Torque:5lb-In/0.5Nm/0.56Nm • Wire Strip length: 7-8mm
Environment	<ul style="list-style-type: none"> • Operating temperature : -40°C~75°C • Storage temperature: -40°C ~85°C • Operating Humidity: 5% to 95% (Non-Condensing)
Housing	<ul style="list-style-type: none"> • Rugged Metal ,IP30 Protection

Dimension	<ul style="list-style-type: none"> • 142 x 36.2 x 105mm (LxWxD)
Installation mounting	<ul style="list-style-type: none"> • DIN Rail and Wall Mount Design
EMC/EMS	<ul style="list-style-type: none"> • CE, FCC
EMI	<ul style="list-style-type: none"> • FCC Part 15 Subpart B Class A • CE EN 55022 Class A
Safety	<ul style="list-style-type: none"> • IEC EN60950-1
Stability Testing	<ul style="list-style-type: none"> • EN 60068-2-6 (Vibration), EN 60068-2-27(Shock), EN 60068-2-32(Free Fall)

Diagram(mm)

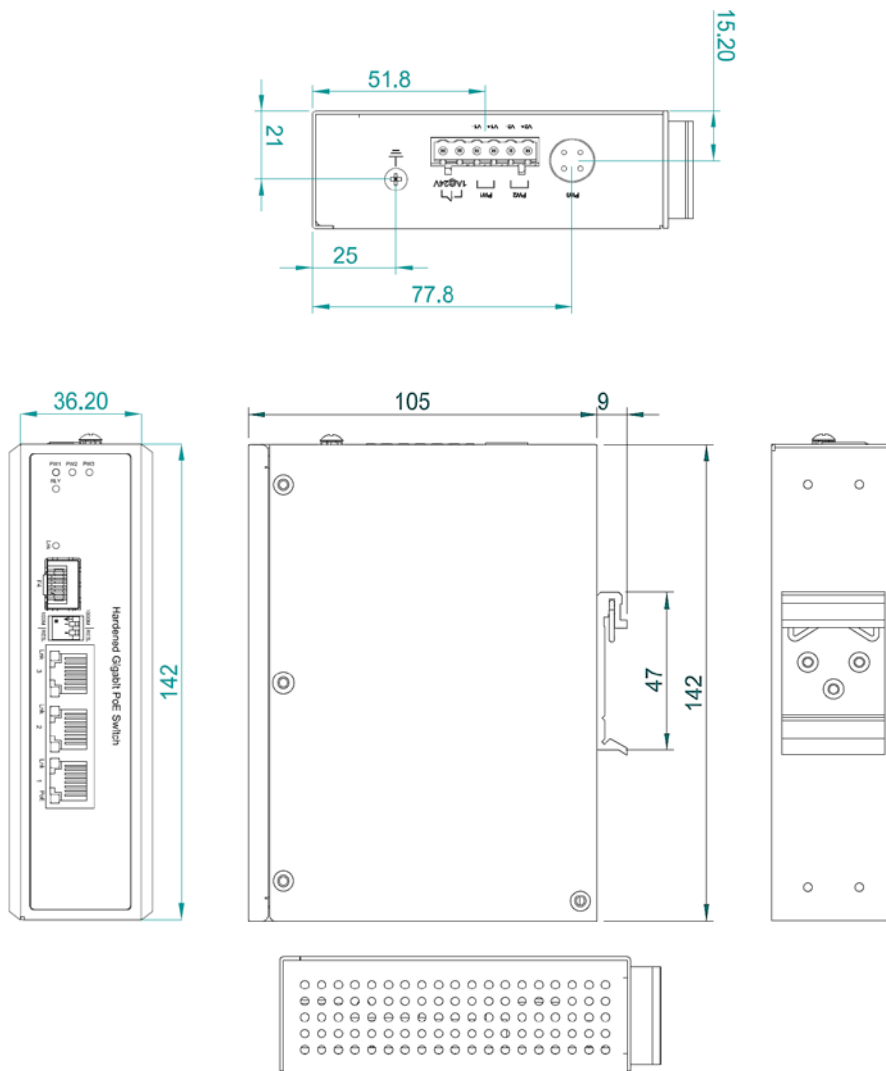

Application

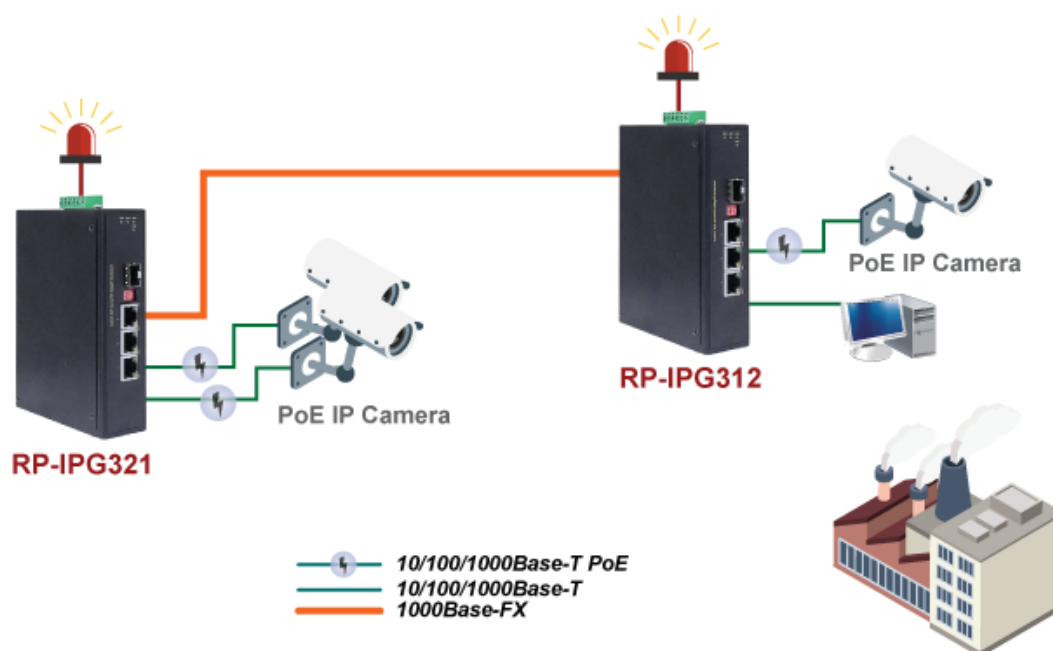

Ordering information

RP-IPG321 3-P Gigabit + 1-SFP(100/1G) slot Industrial Ethernet Switch
w/ 2-P 802.3at PoE, External DC power DIN